

# PALLMANN

---

## Preparation of Rubber

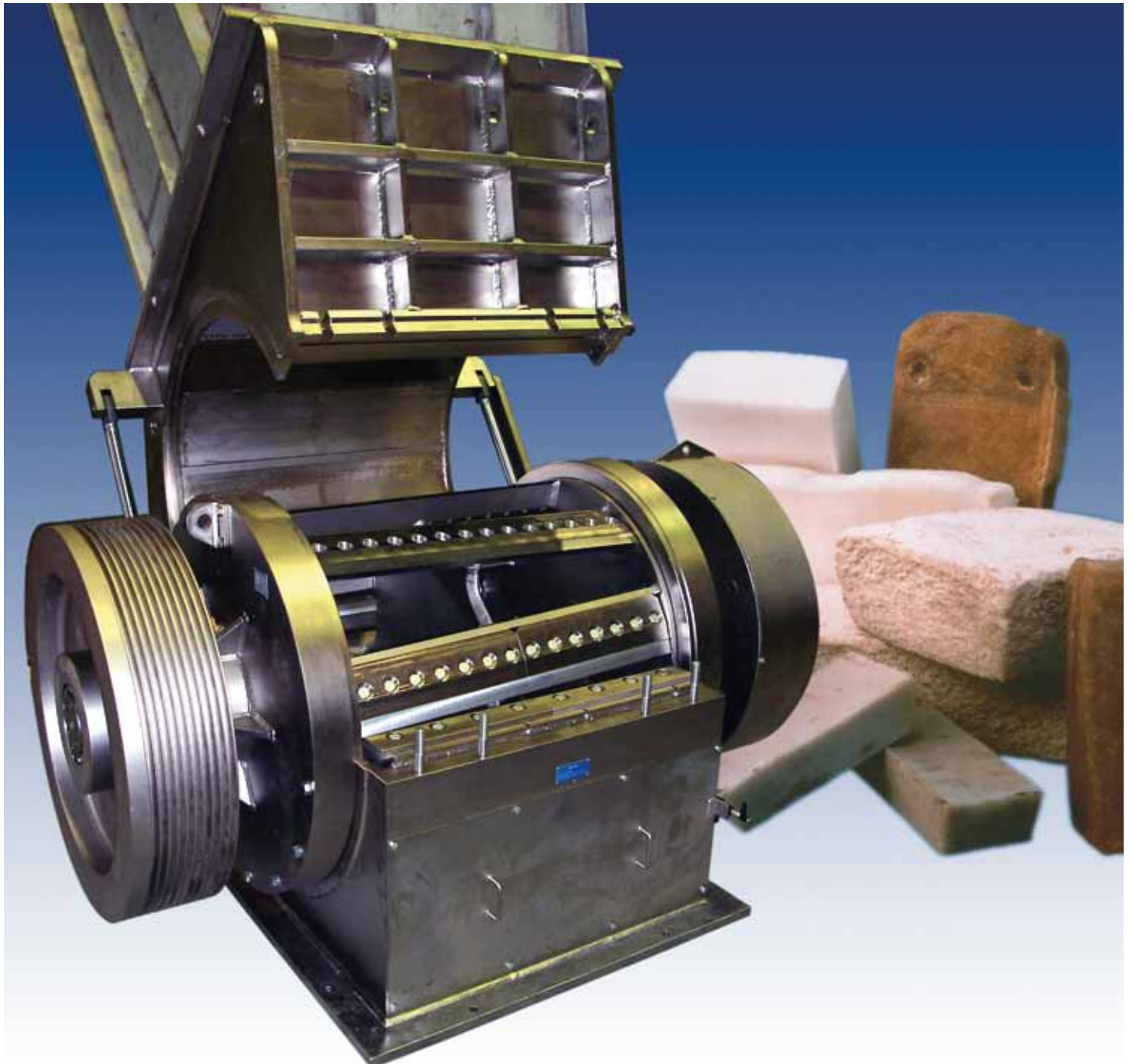

# Preparation of Rubber

Rubber is used in various industrial branches for the production of many technical products, commodity- and consumer goods.

The following are the main applications:

- Labels
- Tires
- Rubber hoses
- Cable coatings
- Cable insulation
- Vapour barriers
- Construction sealants
- Rubber profiles
- Cellular / sponge rubber
- Shoe soles
- Technical rubber articles
- Carpets
- Conveyor belts
- Glues
- Asphalt- and bitumen mixtures
- Compounds
- Adhesives

Rubber is offered in various forms and sizes, i.e. bales, sheets, fibers, chips or crumbs, whereby the most usual form is bales.

For almost any type of processing it is necessary that the bales are size reduced into granules or powder. The result is a shorter dissolving and mixing time as well as energy-saving kneading time. Due to the improved flowability, the rubber material can be easily conveyed and fed into an automatic weight dosing system, therewith achieving continuous manufacturing processes.



For the size reduction of rubber bales, whether natural- or synthetic rubber, PALLMANN delivers the Ultra-Granulators<sup>®</sup>, type C. PALLMANN has designed special guillotine rotors, in open design, without a traversing shaft and with a high-momentum flywheel. This design allows a low friction and therewith temperature-gentle size reduction. In addition, a patented infeed chute with shuttle flaps guarantees a guided material feeding and a dosed material intake.

The machine is easily accessible for quick and thorough cleaning as well as for knife exchange as the upper part of the housing can be hydraulically swung open. Low downtime is guaranteed as the rotor and the stator knives are adjustable outside of the machine and the screen is easily exchangeable. Material transport can be performed mechanically or pneumatically.



## One Step Preparation

Size reduction from a standard size bale to a particle size smaller than 10 mm, can often be accomplished in one step with relatively simple types of rubber such as NBR, SBR, and EPDM. However various rubber types require the addition of a dusting agent.

The rubber bales are feed either by hand or conveyor belt into the PALLMANN Ultra-Granulator<sup>®</sup>, series C and are directly granulated to the desired end size. Particle size is determined by hole size of the internally mounted screen. A pneumatic aspiration system is installed downstream from the granulator to dissipate any heat built up and transport the granulated rubber.

For the size reduction of tough, difficult rubber such as natural or butyl bales, the mill can be equipped with a bale cutter inserted into the infeed chute.



Bale cutter inserted into the infeed chute

PS-C 4-5 guillotine rotor

## Technical Data

Type	PS-C	4-5	4-7.5	6-6	6-9	8-12
Scale-up-factor	f	1.0	1,4	1.55	2.2	3.7
Rotor diameter	mm	400	400	600	600	800
Rotortype		G3	G3	G3	G3	WG6
Drive, main Motor	kW	55	55-75	75-90	75-110	132-250
Throughput rate	kg/h	200-2000	300-2500	350-3000	450-4000	700-7000



If the addition of a dusting agent such as talcum or zinc stearate is required, the dusting agent is injected directly into the cutting chamber via a dosing rotary airlock as well as a high pressure blower. Therefore, directly after the cut, the surfaces of the cut granules are dusted therewith preventing caking. Overdosed dusting agent is separated from the granules by means of dusting agent recovery and can be reused.

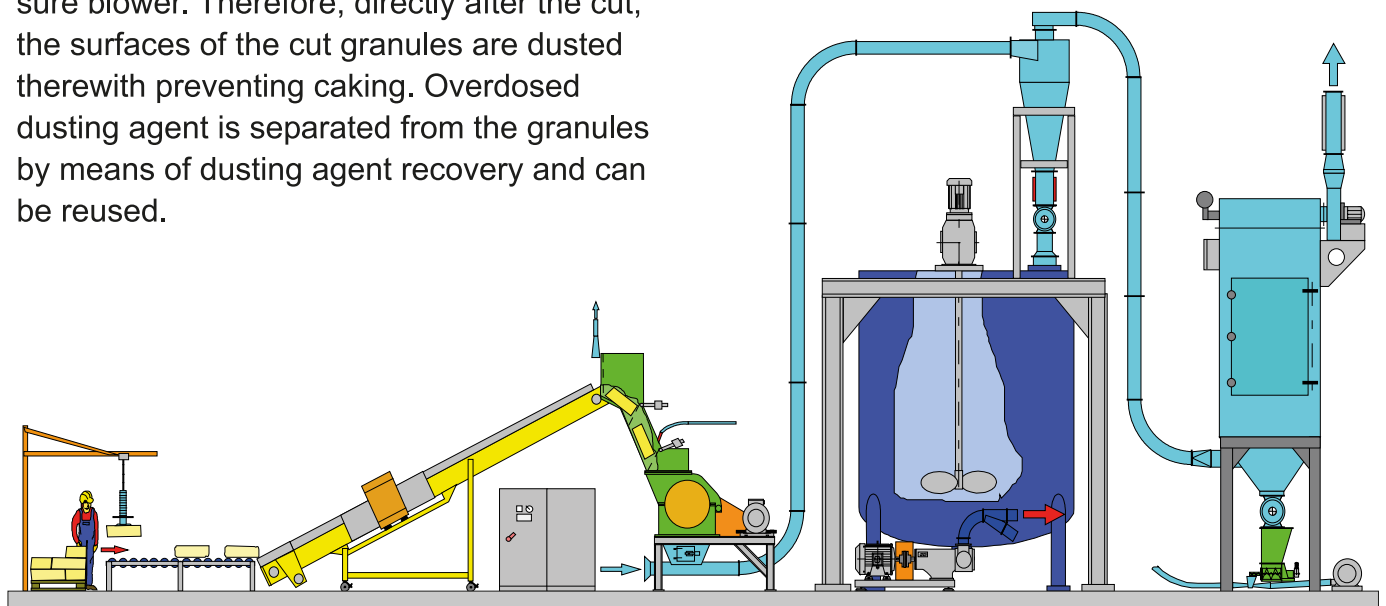

## Two Step Preparation

If standard rubber bales from relatively insensitive types of rubber are to be size reduced to particle sizes smaller than 4 mm, granulating systems operating on a two-step principle are used.

A PALLMANN Ultra-Granulator<sup>®</sup>, series C with guillotine rotor is used for the precutting of the bales. Downstream fine granulating is also performed on a PALLMANN knife mill, equipped with a guillotine rotor. The rubber bales are fed by hand or by means of a conveyor belt into the Ultra-Granulator<sup>®</sup>, series C and are cut to pieces smaller than 40 mm. An additional conveyor belt transports the rubber pieces to the downstream fine granulating system. There, the product is granulated to the desired particle size. The final particle size is determined by the screen mesh size installed in the knife mill.

A pneumatic aspiration system is installed downstream from the rubber knife mill in order to discharge the heat produced during the granulating process and also to transport the granules.

The addition of a dusting agent such as i.e. talcum or zinc stearate is necessary for these two granulating steps. The dusting agent is injected directly into the cutting chamber via a dosing rotary airlock as well as a conveying fan. Therefore, directly after the completed cut, the surfaces of the cut granules are dusted therewith preventing caking. Overdosed dusting agent is separated from the granules by means of dusting agent recovery and can be reused.



PS-C 4-5

## Technical Data

Type	PS-C	4-5	4-7.5	4-10	6-6	6-9	8-6	8-9	8-12
Infeed opening	mm	510x500	510x750	510x1000	560x630	560x930	820x625	820x930	820x1250
Rotor diameter	mm	400	400	400	600	600	800	800	800
Rotortype		G3	G3	G3	G3	G3	WG6	WG6	WG6
Drive, main Motor	kW	37-55	55-90	75-110	55-90	90-132	90-132	110-200	132-250
Throughput rate pre-cutting	kg/h	800-4000	1100-5500	1500-7000	1200-6500	1700-9000	1500-8000	2200-11000	3000-15000
Throughput rate Fine grinding	kg/h	200-2000	300-2500	400-3750	350-3000	450-4000	450-3500	600-5300	800-7000



Dusting agent insatllation



PS-C 4-10



PS-C 4-10

In cases where big bales of natural rubber are to be size reduced with low throughput rates, a bale cutter, type PBS is used for the first step. The bale cutter cuts the big bales into slices before they can be granulated to final size in a second step. Dusting agent is necessary, however, only in step two.

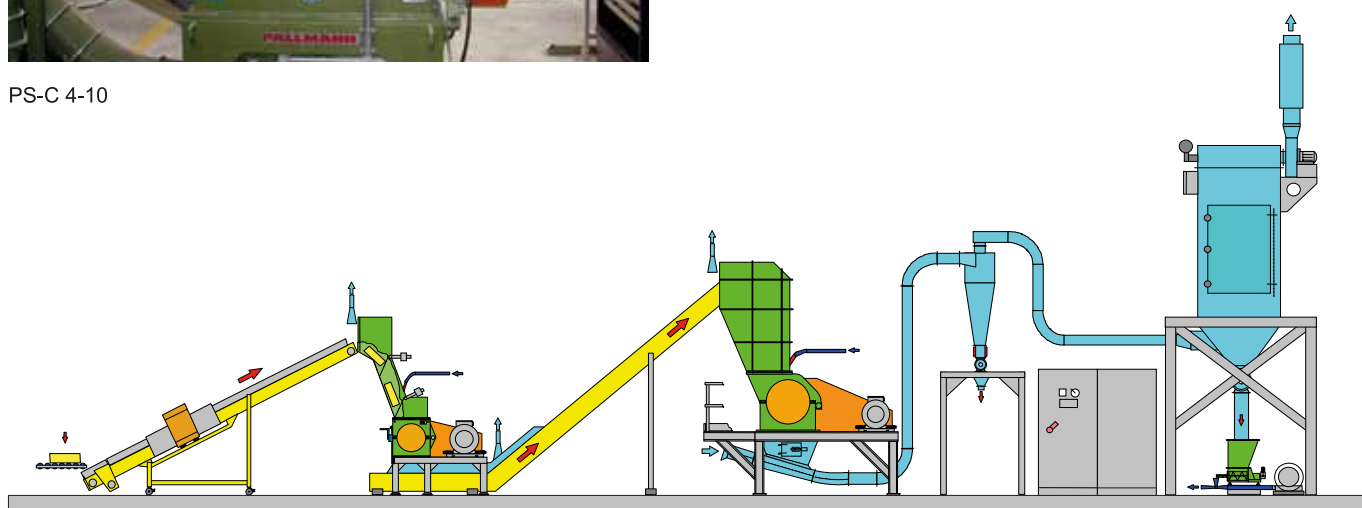

## Tailor Made Systems

Besides the standard systems for the size reduction of rubber bales, PALLMANN supplies individually designed preparation systems for any other type of application in the rubber industry.

PALLMANN Ultra-Granulators<sup>®</sup>, series C are used whether rolled sheets are to be size reduced or granules for rubber floor manufacturers are to be produced.

By using different feed systems such as conveyor belts, live roller conveyors, vibratory feeders or draw-in roller systems, the feed material in a wide variety of forms and sizes can be fed into the Ultra-Granulators<sup>®</sup>, series C. Material storage bins, before and after size reduction, allow a fully automatic and therewith cost-effective operation of the system without tying up valuable personnel resources.

The employment of a lifting device i.e. vacuum gripper assists the operator in preparing the bales for later size reduction.

Dusting agents required during size reduction, regardless of whether they are in dry or liquid form, can be automatically added in the preparation process by means of feed screws, pneumatic conveyor systems or via pumps. Whereby non-bonded dusting agent can be recovered by means of a filter system and be returned to the process according to demands.



PS-C 8-12 EW

Proven sound proofing measures for noise reduction can be offered based on individual requirements. Switch and control systems in proven conventional technology (VPS) and programmable (SPS) technology are part of our standard scope of supply.

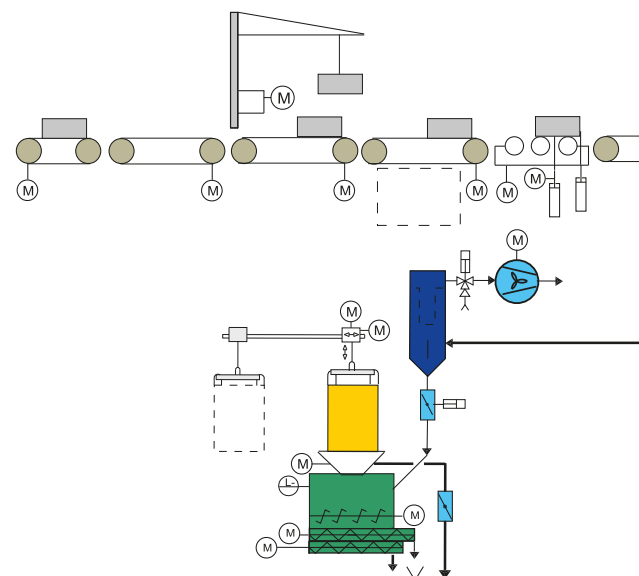



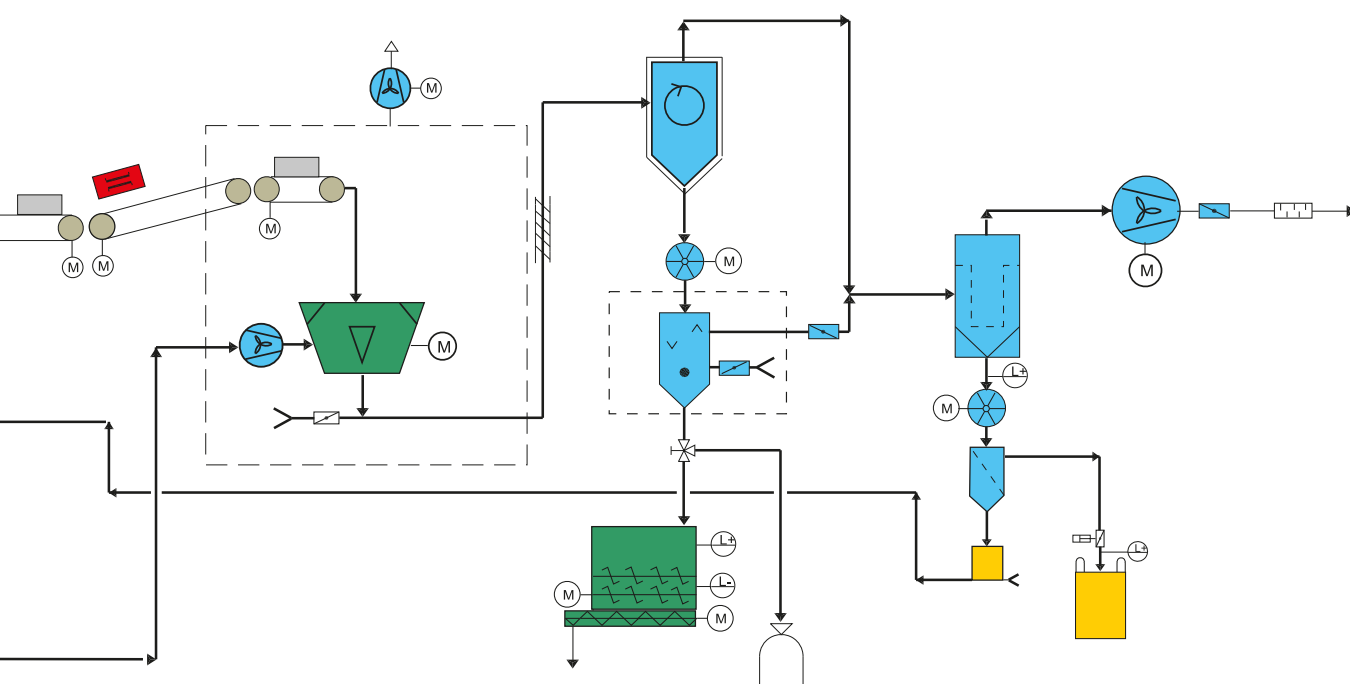

## Pulverizing of Rubber

For the production of compounds for cable manufacturing, seals and other elastic parts as well as for bitumen and asphalt production rubber powders in a wide variety of particle sizes are required.

PALLMANN offers various grinding machines and systems in order to achieve the necessary material qualities and end finenesses.

PolyGrinder<sup>®</sup>, type PKM and turbo mills, type PP are used. Turbofiners<sup>®</sup>, type PLM and pin mills, type PPST are used for special applications.

Granule-shaped feed material is fed into the mill by means of suitable metering systems. A vacuum system, optimally suited for this application, draws the material to be ground away from the mill. Different types of screening systems are used to achieve the desired powder qualities.

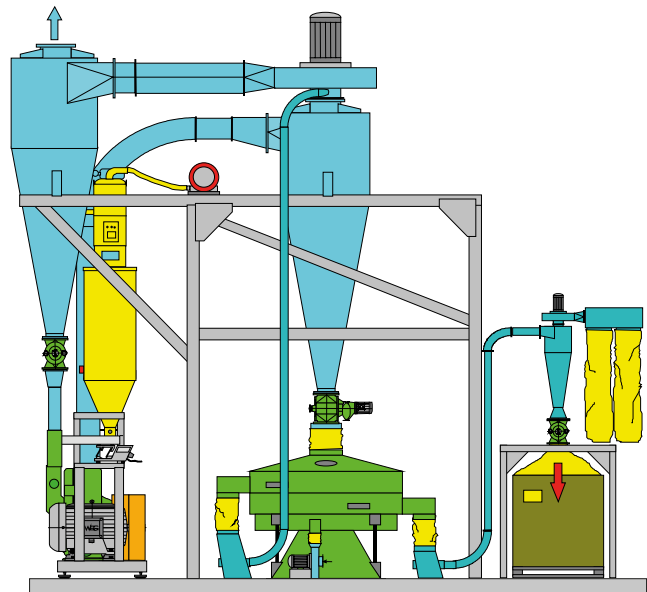
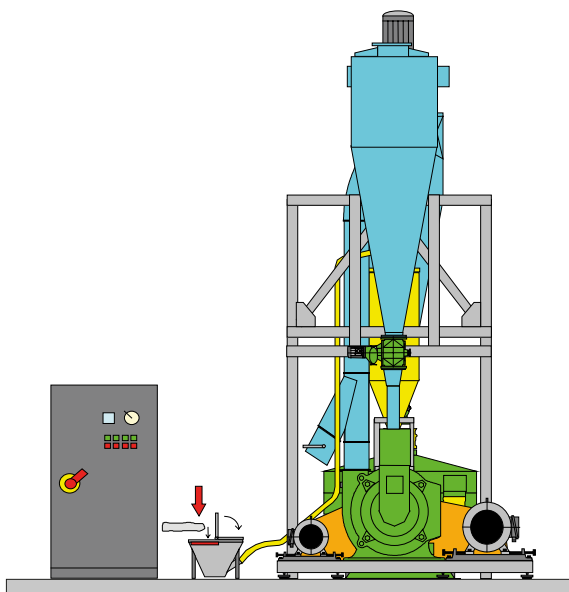



PKM 300 with screening unit

Screened coarse material is reentered into the mill in a closed loop, finished product is weighed into bags, in accordance with the customers' requirements, filled into containers or directly transported into the production process.

Standard systems for installation on the production floor are available. Individual set-up, even in multi-level buildings is possible, depending on the local conditions.



PLM 800



PPST 400

## Technical Data

Type		PP 4S	PP 6S	PP 8S	PKM 300	PKM 450	PKM 600	PKM 800
Grinding chamber diameter	mm	400	600	800	300	450	600	800
Drive, main Motor	kW	7,5 + 15	11 + 30	18,5 + 45	32-37	45-55	55-75	90-160
Throughput rate	kg/h	20-100	90-200	180-360	30-180	120-300	250-300	400-800



## The PALLMANN Group of Companies

The Pallmann Group of companies is the leading manufacturer for size reduction machines and systems for the plastic and recycling industry.

Pallmann Maschinenfabrik develops and manufactures machines and complete systems according to customer requirements or as standard solutions for the preparation of almost any plastics as well as recycling products. In its headquarters in Zweibrücken, Pallmann operates one of the world's largest research and technology centers as well as a training- and service center. More than 130 different test machines are available for the preparation of a wide variety of materials. A downstream laboratory analysis of the test material as well as the preparation on a production scale is possible. In addition to the manufacturing facilities in Europe, North- and South America, the Pallmann Group of companies operates a worldwide spare parts- and service network.



## The PALLMANN Program

### Engineering and Service:

Design and manufacturing  
Research and development  
Production scale testing  
Laboratory analysis  
Worldwide service  
Spare parts  
Controlling  
Process Control  
Installation & Start-up  
Overhaul & Repair

### Products:

Agglomerators  
Pulverizing Systems  
Disc Mills  
Turbo Mills  
Pin Mills  
Laboratory Mills  
Classifier Mills  
Universal Mills  
Complete Grinding Systems  
Knife Mills  
Profile Shredders  
Rubber Granulators  
Pipe Crusher  
Air-Swept Mills  
Impact Mills  
Industrial Granulators  
Cryogenic Grinding Systems

### System solutions for:

Pulverizing  
Granulating  
Agglomerating  
Recycling

PALLMANN Industries Inc.  
820 Bloomfield Ave.  
Clifton NJ 07012  
USA  
Phone +1 973 471 1450  
Fax +1 973 471 7152  
E-mail: [info@pallmannindustries.com](mailto:info@pallmannindustries.com)  
<http://www.pallmann.eu>

PALLMANN do Brasil Ind. e Com Ltda.  
Av. Presidente Juscelino, 11 56  
09950-370 Diadema S.P.  
Brasil  
Phone +55 11 4075 3044  
Fax +55 11 4075 4968  
E-mail: [pallmann@pallmann.com.br](mailto:pallmann@pallmann.com.br)  
<http://www.pallmann.com.br>

PALLMANN GmbH  
Poselenie Moskovskij,  
Kotedzhnij Poselok Bristol  
Uliza Kiplinka 211/1  
142784 Moskau  
Russland  
Phone +7 499 501 77 92  
E-Mail: [info-ru@pallmann.de](mailto:info-ru@pallmann.de)

PALLMANN Maschinenfabrik GmbH & Co.KG  
Wolfslochstraße 51  
66482 Zweibrücken  
Germany  
Phone +49 6332 802 0  
Fax +49 6332 802 521  
E-mail: [plastics@pallmann.eu](mailto:plastics@pallmann.eu)  
<http://www.pallmann.eu>

PALLMANN Technology (Beijing) Co.,Ltd.  
3F, Room 315-319, Union Development No.8,  
Building, No.728, Xin Hua Road  
200052 Shanghai, China  
Phone +86 21 6283 4454  
Fax +86 21 6283 2277  
E-mail: [Jie.Tang@pallmann.eu](mailto:Jie.Tang@pallmann.eu)  
[www.pallmannchina.com](http://www.pallmannchina.com)